

SHOCK BLADE

ORDER FORM 2023

Tel: 951-808-9131 FAX: 951-808-9949
Toll Free: 800-892-8998 www.colourswheelchair.com

DEALER		COLOURS INFORMATION For Office Use Only	
Dealer:		Order Date:	S/N:
Account:	P.O.#:		
Ordered By:			
Customer Name:			
Customer Weight:			

CHAIR INFORMATION	PRICE
New SHOCK BLADE K0005	Base Wheel Chair Price K0005 \$ 3,100
7000 series aluminum frame	Air Ride System \$ 2,100
Fixed FSH-RSH with Air Ride System Suspension (E1015)	Total Section A \$
Max. Capacity 250Lbs	Total Section B \$
<input type="checkbox"/> Heavy Duty Frame(250-300lbs) \$750	Total Section C(Custom Parts Color)
NOTE Main Frame : Lifetime Warranty(5 years) *See warranty policy	Total Section D \$
	Total Section E \$
	Total Section F \$
	Total Section G \$
	Total Section H \$
	ORDER GRAND TOTAL \$

A FRAME COLORS & PARTS COLORS

FRAME COLORS	<input type="checkbox"/> Tiffany Blue	<input type="checkbox"/> Sparkle Burgundy	<input type="checkbox"/> Neon Yellow*	<input type="checkbox"/> Brass Metallic	<input type="checkbox"/> Shocker Yellow	
Powder-Coated	<input type="checkbox"/> Gloss Black	<input type="checkbox"/> Twilight Flake	<input type="checkbox"/> Yellow	<input type="checkbox"/> Magenta	<input type="checkbox"/> Fire Engine Red	<input type="checkbox"/> White
	<input type="checkbox"/> Candy Blue	<input type="checkbox"/> Candy Purple	<input type="checkbox"/> Candy Green	<input type="checkbox"/> Candy Red	<input type="checkbox"/> Candy Raspberry	<input type="checkbox"/> Cobalt Blue
	<input type="checkbox"/> Matte Gray	<input type="checkbox"/> Matte Purple	<input type="checkbox"/> Matte Blue	<input type="checkbox"/> Matte Green	<input type="checkbox"/> Matte Black	<input type="checkbox"/> Matte Red
	<input type="checkbox"/> Reed Green	<input type="checkbox"/> Neon Green	<input type="checkbox"/> Orange Sparkle	<input type="checkbox"/> Mellon Yellow	<input type="checkbox"/> Gun Smoke Silver	<input type="checkbox"/> Blue Lilac
	<input type="checkbox"/> Sparkle Sky Blue	<input type="checkbox"/> Granny Sparkle Green				\$ STD
Specials	<input type="checkbox"/> Polished Aluminum.....					\$ 920
	<input type="checkbox"/> 24 karat Gold Plated.....					\$ CFP
PARTS COLORS (Custom Parts Color Section, Please see Section F)						
STD Color	Black Color (*Suspension Springs-Silver Color Only.....					\$ STD
Custom Color Main Bolt on Parts One Color Package	<input type="checkbox"/> Powder-Coated ().....					\$ 690
Including: Backrest, Foot Plate, Footrest Rings, Backrest Brackets, Saddle Stops, Forks & Knurl Nuts, Caps, Front Suspension Springs ★marked parts	<input type="checkbox"/> Polished.....					\$ 863
	<input type="checkbox"/> 24 karat Gold..... Plated-					\$ CFP
Custom Color Suspension Unit One Color Package	<input type="checkbox"/> Powder-Coated ().....					\$ 456
Including: Axle Holders, Upper A-Arms, Lower A-Arms, Suspension Main Frame..... ★marked parts	<input type="checkbox"/> Polished.....					\$ 920
	<input type="checkbox"/> 24 karat Gold..... Plated-					\$ CFP

B FRAME MEASUREMENTS 1/2

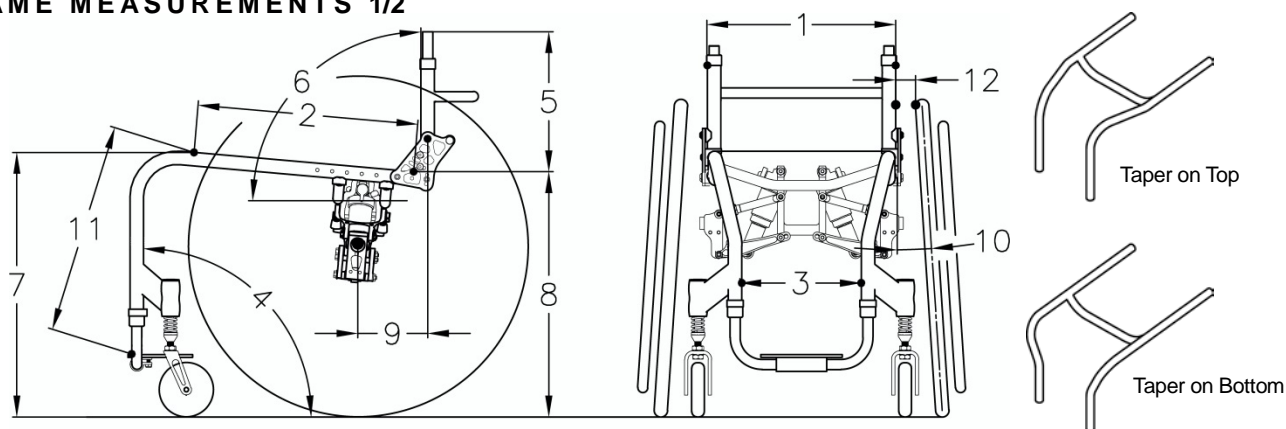

1. SEAT WIDTH	<input type="checkbox"/> 13" <input type="checkbox"/> 14" <input type="checkbox"/> 15" <input type="checkbox"/> 16" <input type="checkbox"/> 17" <input type="checkbox"/> 18" <input type="checkbox"/> 19" <input type="checkbox"/> 20" E2201	\$ STD \$ 345								
2. SEAT DEPTH * Only Choose One Option	<input type="checkbox"/> Net Seat Depth <input type="checkbox"/> 13" <input type="checkbox"/> 14" <input type="checkbox"/> 15" <input type="checkbox"/> 16" <input type="checkbox"/> 17" <input type="checkbox"/> 18" <input type="checkbox"/> 19" <input type="checkbox"/> Depth Adj. Frame <input type="checkbox"/> Short Frame (16" Depth) Set at <input type="checkbox"/> 13" <input type="checkbox"/> 14" <input type="checkbox"/> 15" <input type="checkbox"/> 16" . . <input type="checkbox"/> Long Frame (19" Depth) Set at <input type="checkbox"/> 16" <input type="checkbox"/> 17" <input type="checkbox"/> 18" <input type="checkbox"/> 19" . .	\$ STD \$ 345 \$ STD \$ STD								
	<input type="checkbox"/> Aluminum Seat Base for (250-300lbs) recommended E2231 <input type="checkbox"/> Positioning Frame Add (")	\$ 324 \$ 200								
	<input type="checkbox"/> Ergo Seat Tubing Depth (") *Measurement must be 2.5" longer than your Center of Gravity	\$ 230								
3. FOOTREST WIDTH	<input type="checkbox"/> STD (Seat Width Minus 5") <input type="checkbox"/> Taper on Top <input type="checkbox"/> Taper on Bottom <input type="checkbox"/> Custom (") <input type="checkbox"/> Taper on Top <input type="checkbox"/> Taper on Bottom <input type="checkbox"/> No Taper (Seat Width Minus 2").	\$ STD \$ 173 \$ STD								
FOOT PLATE STYLE	<input type="checkbox"/> Standard single loop with adjust. height & angle. STD Foot Plate <input type="checkbox"/> Single Flip-Back-single loop (no riser avail) with adjust. height & angle. STD Foot Plate K0040, K0045	\$ STD \$ 173								
<input type="checkbox"/> Foot Propel w/ Stabilizer Bar Style	STD Foot Plate Size Chart <table border="1" style="margin-left: 20px;"> <thead> <tr> <th>Your Footrest Width</th> <th>Foot Plate Size</th> </tr> </thead> <tbody> <tr> <td>8.5"-10.0"</td> <td>W6.5"xD5"</td> </tr> <tr> <td>10.5"-13.0"</td> <td>W8.5"xD6.5"</td> </tr> <tr> <td>13.5"-17.0"</td> <td>W11"xD6.5"</td> </tr> </tbody> </table>	Your Footrest Width	Foot Plate Size	8.5"-10.0"	W6.5"xD5"	10.5"-13.0"	W8.5"xD6.5"	13.5"-17.0"	W11"xD6.5"	
Your Footrest Width	Foot Plate Size									
8.5"-10.0"	W6.5"xD5"									
10.5"-13.0"	W8.5"xD6.5"									
13.5"-17.0"	W11"xD6.5"									
CUSTOM FOOT PLATE <input type="checkbox"/> Dual Flip Up w/ Welded Stabilizer Bar (\$250 up charged)	<input type="checkbox"/> Custom Foot Plate with adjust. height & angle *Available Solid Plate Only	\$ 115								
<input type="checkbox"/> Add Anti-Skid Tape (\$20 up charged)	<input type="checkbox"/> Custom Tubular Footrest *Measurement must be 2.5" shorter than your Footrest Width	\$ 331								
4. FRAME ANGLE	<input type="checkbox"/> 75° <input type="checkbox"/> 80° <input type="checkbox"/> 85° <input type="checkbox"/> 90° to the ground <input type="checkbox"/> Custom (°) to the ground *Up to 65°	\$ STD \$ NCO								

B FRAME MEASUREMENTS 2/2

5. BACKREST HEIGHT	<input type="checkbox"/> 8" <input type="checkbox"/> 9" <input type="checkbox"/> 10" <input type="checkbox"/> 11" <input type="checkbox"/> 12" <input type="checkbox"/> 13" <input type="checkbox"/> 14" <input type="checkbox"/> 15" <input type="checkbox"/> 16" <input type="checkbox"/> 17" <input type="checkbox"/> 18"	Adj. Range Adj. Range Adj. Range		\$ STD														
<small>* Rigidizer bar 3.25" deep std.</small>																		
TYPE	<input type="checkbox"/> Locking mechanism with adjust. height & angle \$ STD																	
	<input type="checkbox"/> Double Locking mechanism with adjust. height & angle \$ 40																	
	<input type="checkbox"/> Folding with adjust. height & angle \$ NCO																	
CUSTOM	<input type="checkbox"/> Welded Backrest Angle Set at (") to the ground *Non Folding Backrest . . . only. \$ 200																	
	<input type="checkbox"/> Welded Side Guards *Non Folding Backrest \$ 518																	
<input type="checkbox"/> Custom Backrest \$ 200																		
<small>(ie: double rigidizer bars, custom depth, custom height, etc)</small>																		
6. BACKREST ANGLE	Set at (°) to the ground *STD 90°			\$ STD														
7. FRONT SEAT HEIGHT	<input type="checkbox"/> 16.0" <input type="checkbox"/> 16.5" <input type="checkbox"/> 17.0" <input type="checkbox"/> 17.5" <input type="checkbox"/> 18.0" <input type="checkbox"/> 18.5" <input type="checkbox"/> 19.0" <input type="checkbox"/> 19.5" <input type="checkbox"/> 20.0" <input type="checkbox"/> 20.5" <input type="checkbox"/> 21.0"			\$ STD														
Front Seat Height Ranges		<table border="1" style="width:100%; border-collapse: collapse;"> <thead> <tr> <th>Caster Wheel Size</th> <th>Front Seat Height</th> </tr> </thead> <tbody> <tr> <td style="text-align:center;">3" Caster</td> <td style="text-align:center;">16.0" - 19.5"</td> </tr> <tr> <td style="text-align:center;">4" Caster</td> <td style="text-align:center;">16.0" - 20.0"</td> </tr> <tr> <td style="text-align:center;">5" Caster</td> <td style="text-align:center;">16.0" - 21.0"</td> </tr> </tbody> </table>	Caster Wheel Size	Front Seat Height	3" Caster	16.0" - 19.5"	4" Caster	16.0" - 20.0"	5" Caster	16.0" - 21.0"								
Caster Wheel Size	Front Seat Height																	
3" Caster	16.0" - 19.5"																	
4" Caster	16.0" - 20.0"																	
5" Caster	16.0" - 21.0"																	
8. REAR SEAT HEIGHT	<input type="checkbox"/> 16.0" <input type="checkbox"/> 16.5" <input type="checkbox"/> 17.0" <input type="checkbox"/> 17.5" <input type="checkbox"/> 18.0" <input type="checkbox"/> 18.5" <input type="checkbox"/> 19.0" 			\$ STD														
Rear Seat Height Ranges		<table border="1" style="width:100%; border-collapse: collapse;"> <thead> <tr> <th>Rear Tire Size</th> <th>Rear Seat Height</th> </tr> </thead> <tbody> <tr> <td style="text-align:center;">24"x1"(540)</td> <td style="text-align:center;">16.0" - 18.5"</td> </tr> <tr> <td style="text-align:center;">24"x1 3/8"(540)</td> <td style="text-align:center;">16.5" - 19.0"</td> </tr> <tr> <td style="text-align:center;">25"x1"(559)</td> <td style="text-align:center;">16.5" - 19.0"</td> </tr> <tr> <td style="text-align:center;">24"x2"(540)</td> <td style="text-align:center;">17.0" - 19.0"</td> </tr> <tr> <td style="text-align:center;">26"x1"(590)</td> <td style="text-align:center;">17.0" - 19.0"</td> </tr> <tr> <td style="text-align:center;">25"x1.95"(559)</td> <td style="text-align:center;">17.0" - 19.0"</td> </tr> </tbody> </table>	Rear Tire Size	Rear Seat Height	24"x1"(540)	16.0" - 18.5"	24"x1 3/8"(540)	16.5" - 19.0"	25"x1"(559)	16.5" - 19.0"	24"x2"(540)	17.0" - 19.0"	26"x1"(590)	17.0" - 19.0"	25"x1.95"(559)	17.0" - 19.0"		
Rear Tire Size	Rear Seat Height																	
24"x1"(540)	16.0" - 18.5"																	
24"x1 3/8"(540)	16.5" - 19.0"																	
25"x1"(559)	16.5" - 19.0"																	
24"x2"(540)	17.0" - 19.0"																	
26"x1"(590)	17.0" - 19.0"																	
25"x1.95"(559)	17.0" - 19.0"																	
*No Custom Modifications																		
9. CENTER OF GRAVITY	★ <input type="checkbox"/> 1.5" ★ <input type="checkbox"/> 2.0" <input type="checkbox"/> 2.5" <input type="checkbox"/> 3.0" <input type="checkbox"/> 3.5" <input type="checkbox"/> 4.0" <input type="checkbox"/> 4.5" <input type="checkbox"/> 5.0" ★Not Available w / Net Seat Depth Frame			\$ STD														
10. CAMBER ANGLE	<input type="checkbox"/> 0° <input type="checkbox"/> 2° <input type="checkbox"/> 4° 			\$ STD														
11. FRONT OF SEAT SLING TO FRONT OF FOOTREST	★ <input type="checkbox"/> 15.0" ★ <input type="checkbox"/> 15.5" ★ <input type="checkbox"/> 16.0" <input type="checkbox"/> 16.5" <input type="checkbox"/> 17.0" <input type="checkbox"/> 17.5" <input type="checkbox"/> 18.0" <input type="checkbox"/> 18.5" <input type="checkbox"/> 19.0" <input type="checkbox"/> 19.5" ★Not Available w / 19.0", 19.5", 20.0", 20.5", 21.0" Front Seat Height ★Measurement must be 1.5" shorter than your Front Seat Height			\$ STD														
HIGH MOUNT <small>With Risers or Clamps</small>	<input type="checkbox"/> 11.0" <input type="checkbox"/> 11.5" <input type="checkbox"/> 12.0" <input type="checkbox"/> 12.5" <input type="checkbox"/> 13.0" <input type="checkbox"/> 13.5" <input type="checkbox"/> 14.0" <input type="checkbox"/> 14.5" <input type="checkbox"/> 15.0" <input type="checkbox"/> 15.5" <input type="checkbox"/> 16.0" K0040			\$ 86														
12. INSIDE WHEEL CLEARANCE	<input type="checkbox"/> 3/4"* <input type="checkbox"/> 1" <input type="checkbox"/> 1 1/4" <input type="checkbox"/> 1 1/2" <input type="checkbox"/> 1 3/4" <input type="checkbox"/> 2" *3/4" Inside wheel clearance not available with 2 degree camber. (with the exception of Y-360 wheels) *3/4" Inside wheel clearance not available with Armrest			\$ STD														
REAR SUSPENSION RATING	<input type="checkbox"/> Set up 50psi (For 80 lbs-110 lbs weight) <input type="checkbox"/> Set up 100psi (For 170 lbs-200 lbs weight) <input type="checkbox"/> Set up 60psi (For 110 lbs-140 lbs weight) <input type="checkbox"/> Set up 120psi (For 200 lbs-230 lbs weight) <input type="checkbox"/> Set up 80psi (For 140 lbs-170 lbs weight) <input type="checkbox"/> Set up 150psi (For 230 lbs-250 lbs weight)			\$ STD														
SHOCK OPTION	<input checked="" type="checkbox"/> Fox Racing Shox 300 HP Pump *Customer Needs Pump To Adjust Rear Suspension Rating <input type="checkbox"/> Omit Air Pro System			\$ STD \$ -400														
Color AirTubes: <input type="checkbox"/> Black																		

1. SEAT WIDTH

Measure from outside of seat tube to the outside of the opposite seat tube.

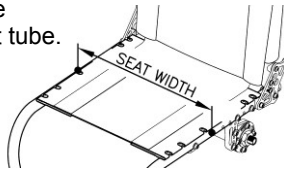

2. SEAT DEPTH

Measure from at the front bottom of backrest tube to the front edge of seat sling.

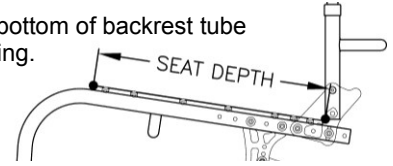

3. FOOTREST WIDTH

Measure from inside of front frame tube to inside of opposite front frame tube.

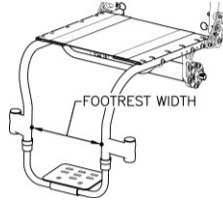

4. FRAME ANGLE

Measure angle frame front to floor.

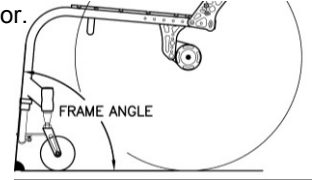

5. BACKREST HEIGHT

Measure from top of back post to seat sling at front bottom of backrest tube.

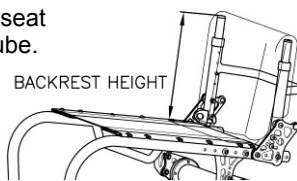

6. BACKREST ANGLE

Measure angle from front of back post to floor.

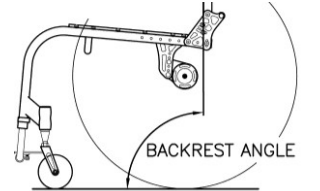

7. FRONT SEAT HEIGHT

Measure from floor to top of seat sling at front edge.

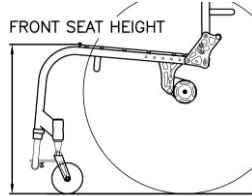

8. REAR SEAT HEIGHT

Measure from floor to top of seat sling at front bottom of backrest tube.

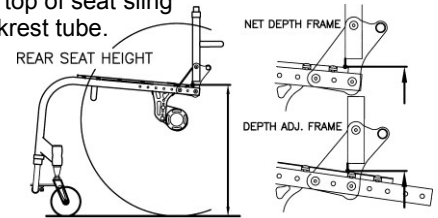

9. CENTER OF GRAVITY

Measure from center of back tube at the folding pivot to the center of the rear axle.

(If welding backrest is selected, Measure from center of back tube at the seat tube to the center of the rear axle.)

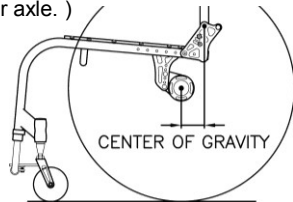

10. CAMBER ANGLE

Measure angle from wheel to vertical at floor.

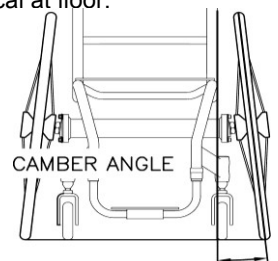

11. FRONT OF SEAT SLING TO FOOTREST

ADULT CHAIR

Measure from top of seat sling at front edge to top of foot plate at front edge.

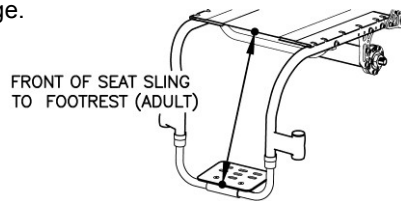

PEDIATRIC CHAIR

Measure vertical from top of seat sling at front edge to top of foot plate.

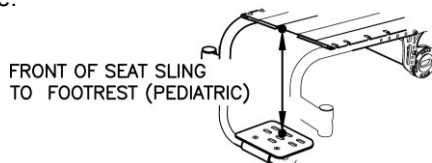

12. INSIDE WHEEL CLEARANCE

Measure from outside of seat back tube to inside of rear tire.

(If side guards are selected, measure from outside of side guards to inside of rear tire.)

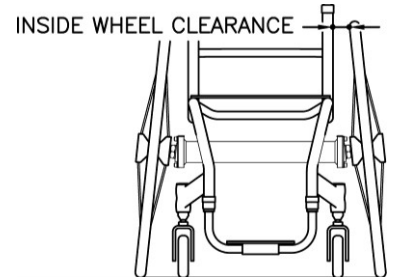

C SPECIAL PARTS COLORS (Please allow an additional 1-2 weeks delivery)

PARTS COLORS						
Powder-Coated	Gloss Black	Twilight Flake	Yellow	Magenta	Fire Engine Red	White
	Blue Lilac	Candy Blue	Candy Purple	Candy Green	Candy Raspberry	Cobalt Blue
	Brass Metal	Matte Gray	Matte Purple	Matte Blue	Matte Green	Matte Black
	Sparkle Burgundy	Reed Green	Neon Green	Orange Sparkle	Mellon Yellow	Gun Smoke Silver
	Shocker Yellow	Neon Yellow	Granny Sparkle Green	Sparkle Sky Blue		

Special Colors	Polished Aluminum	
	24 karat Gold Plated	*Please allow an additional 4 weeks delivery

Please Choose the Color for each Part

*Parts not selected will be black color. (Suspension Spring: Silver Color)

*Minimum 3 parts selected per order.

*PC=Powder-Coated

Saddle Stops

- PC () \$55
- Polished \$132
- Gold Plated \$CFP

Backrest Frame

- PC () \$173
- Polished \$259
- Gold Plated CFP

Backrest Brackets

- PC () \$125
- Polished \$132
- Gold Plated \$CFP

Foot Plate

- PC () \$70
- Polished \$104
- Gold Plated \$CFP

Footrest Rings

- PC () \$50
- Polished \$60
- Gold Plated \$CFP

Footrest Tubes

- PC N/A
- Polished \$100
- Gold Plated \$CFP

Foot Plate Clamps

- PC () \$70
- Polished \$98
- Gold Plated \$CFP

Caps

- PC () \$45
- Polished N/A
- Gold Plated N/A

Front Springs

- PC () \$45
- Polished N/A
- Gold Plated N/A

Forks & Knurl Nuts

- PC () \$90
- Polished \$104
- Gold Plated \$CFP

Suspension Main Frame

- PC () \$200
- Polished \$460
- Gold Plated \$CFP

Upper A-Arms

- PC () \$138
- Polished \$345
- Gold Plated \$CFP

Lower A-Arms

- PC () \$138
- Polished \$322
- Gold Plated \$CFP

Axle Receiver Holder

- PC () \$83
- Polished \$207
- Gold Plated \$CFP

D COMPONENTS

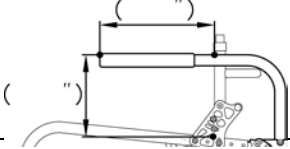
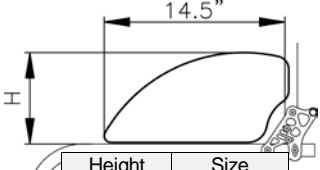
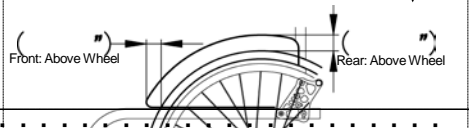
WHEEL LOCKS			
<input type="checkbox"/> New Solutions Push to Lock	<input type="checkbox"/> w/ 2" Extension Handle (\$92up charge)		\$ STD
<input type="checkbox"/> Gallop Push to Lock / Anodized			\$ STD
<input type="checkbox"/> Primo Push To Lock / Anodized			\$ 115
<input type="checkbox"/> Question Mark Style Scissor			\$ 80
<input type="checkbox"/> NEW Compact Scissor Lock / Anodized Black Only			\$ 146
<input type="checkbox"/> Gallop Scissor Lock / Anodized			\$ 146
<input type="checkbox"/> D's Locks Brake	Mount on Frame <input type="checkbox"/> Right Side <input type="checkbox"/> Left Side		\$ 1,360
PUSH HANDLES		*If you are ordering push handles, You must select the backrest locking mechanism.	
<input type="checkbox"/> Integrated w/Fixed Backrest Height / Anodized Black Only			\$ STD
<input type="checkbox"/> Bolt-on / Anodized Black Only	Specify Height from floor -(_____")		\$ 188
<input type="checkbox"/> Bolt-on w/Quick Release / Anodized Black Only	Specify Height from floor -(_____")		\$ 252
<input type="checkbox"/> NEW Height Adj. / Anodized Black Only	Specify Maximum height from floor -(_____")		\$ 390
NEW ARM RESTS		Anodized Black Only	
<input type="checkbox"/> Fixed Tubular Armrest	Adj. Angle and Height	Height from seat sling Set at : <input type="checkbox"/> 8" <input type="checkbox"/> 9" <input type="checkbox"/> 10" <input type="checkbox"/> 11" <input type="checkbox"/> 12" E0973	\$ 330
<input type="checkbox"/> Swing Away Tubular Armrest	Adj. Angle and Height	Height from seat sling Set at : <input type="checkbox"/> 8" <input type="checkbox"/> 9" <input type="checkbox"/> 10" <input type="checkbox"/> 11" <input type="checkbox"/> 12" E0973	\$ 330
<input type="checkbox"/> Flip-Up Armrest	<input type="checkbox"/> w/Fixed Tubular Armrest	Height from seat sling Set at : <input type="checkbox"/> 8" <input type="checkbox"/> 9" <input type="checkbox"/> 10" <input type="checkbox"/> 11" <input type="checkbox"/> 12" E0973	\$ 330
	Adj. Angle <input type="checkbox"/> w/ Swing Away Tubular Armrest	Height from seat sling Set at : <input type="checkbox"/> 8" <input type="checkbox"/> 9" <input type="checkbox"/> 10" <input type="checkbox"/> 11" <input type="checkbox"/> 12" E0973	\$ 330
	<input type="checkbox"/> Custom Length & Height (\$173 up charge)		
	*Specify Height & Length →		
ANTI-TIPPERS			
<input type="checkbox"/> Press Release Removable Anti-tipper(pair)		E0971	\$ 330
SIDE GUARDS			
<input type="checkbox"/> Rigid Side Guards - Black ABS	<input type="checkbox"/> Non-Removable <input type="checkbox"/> Removable <input type="checkbox"/> Removable w/Hole (\$14 up charge)		\$ 187
Color: Black Only	Size: <input type="checkbox"/> STD <input type="checkbox"/> Medium <input type="checkbox"/> Cut to Wheel (\$100 up charge) Measurement		
<input type="checkbox"/> Rigid Side Guards - Aluminum	<input type="checkbox"/> Non-Removable <input type="checkbox"/> Removable		\$ 260
	Size: <input type="checkbox"/> Medium Only <input type="checkbox"/> Cut to Wheel (\$100 up charge) Measurement		
	Color <input type="checkbox"/> Black (STD) <input type="checkbox"/> Pol. Aluminum (STD)		
	<input type="checkbox"/> Powder Coated () (\$140 up charge)		
	<input type="checkbox"/> Gold Plate (+CFP)		
			
<input type="checkbox"/> Fabric Clothing Guards	Black Nylon w/Velcro		\$ 108
SEAT CUSHION		*Please see section G for other cushion choices.-	
<input type="checkbox"/> Foam Cushion	w/Nylon Black Cover Thickness <input type="checkbox"/> 1" <input type="checkbox"/> 2" <input type="checkbox"/> 3" <input type="checkbox"/> 4"		\$ CFP
	<input type="checkbox"/> Custom Cushion Cover (Std. Foam Cushion Only) -Select Fabric () (\$104 up charge)		
ACCESSORIES			
<input type="checkbox"/> Frame Protectors	/ Black Leather/Zipper Type		\$ 108
<input type="checkbox"/> Gel Ovation Protector Wraps	Gel Silicone <input type="checkbox"/> Short (1/2") <input type="checkbox"/> Long (3")		\$ 132
<input type="checkbox"/> E0978 Seat Belt	w/Auto Buckle Black Belt Only	E0978	\$ 113
<input type="checkbox"/> Tie Down Brackets	4pcs. <input type="checkbox"/> Bolted <input type="checkbox"/> Welded		\$ 278
<input type="checkbox"/> Calf Strap	<input type="checkbox"/> Black <input type="checkbox"/> Matching Fabric (\$65 up charge) -Select Fabric ()		\$ 35
<input type="checkbox"/> Bodypoint Padded Calf Strap	<input type="checkbox"/> (14"-16" footrest width) <input type="checkbox"/> (16"-20" footrest width) <input type="checkbox"/> (20"-24" footrest)		
	\$89 \$95 \$102		
<input type="checkbox"/> Hanging Zipper Pouch	<input type="checkbox"/> Black <input type="checkbox"/> Matching Fabric (\$75) or <input type="checkbox"/> Leather (\$80) Custom Size Width: Length:		\$ 86
<input type="checkbox"/> Matching Fabric on Padded Side Guards	-Select Fabric ()		\$ 278
UPHOLSTERY CHOICE & COLOR		*Positioning Back Available. Please see Section E	
<input type="checkbox"/> Standard Adjustable Height Backrest	(Black)		\$ STD
<input type="checkbox"/> Adjustable Tension Backrest	Black Only (*Not available with 8" Backrest Height)		\$ 173
Options	<input type="checkbox"/> Fun Fabric: For Std. or Adj. Style (Choose From Choices on Page 7 and write below) (\$ 92 up charge)		
	<input type="checkbox"/> Backrest Leather Trim (outside panels)		\$ CFP

FABRIC CHOICE SHEET

1. Camouflage Girls

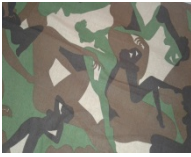

2. Purple Zebra



3. Silver Grey Snake



5. Laughing Skulls



6. Purple Snake



7. Sweetheart Pinup Girls



9. Blue Flames

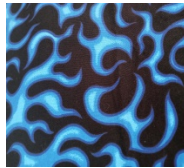

10. Arctic Camo



11. Furry Friends



12. Supercars



13. Urban Camo

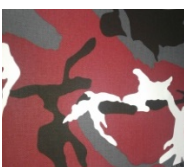

14. Superbikes



15. Sizzle Flames



16. Hot Rod Flames



17. Skulls w/ Attitude



18. Sweet Pink

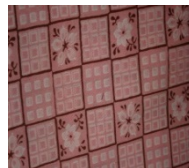

19. Heart and Soul



20. Home Run



21. Fuzzy Giraffe

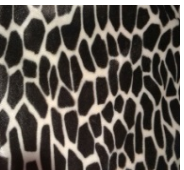

22. Cheetah



23. Paperweight Cobalt



24. Zig Zag Dots



25. Smokey Tribal Flames

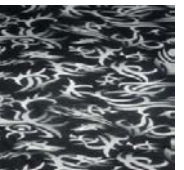

26. Rose and Rebellion



27. Tattoo Adventure(Cream

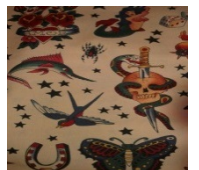

28. Red Tribal Flames

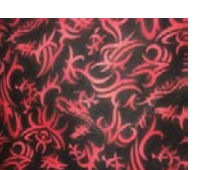

29. Tattoo Adventure(Black)

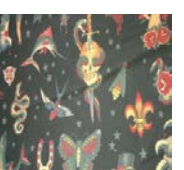

30. Butterfly Bandana

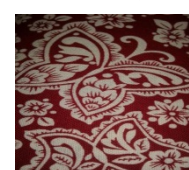

31. Tatsu Dragon

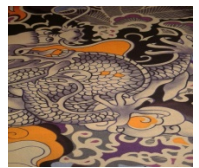

E TIRES, CASTERS, & FORKS



TIRES						
<input type="checkbox"/>	Primo High Pressure Tire	<input type="checkbox"/> 24"x1" <input type="checkbox"/> 25"x1" <input type="checkbox"/> 26"x1"	Gray Tire w/ black	E2211/E2212	\$	STD
<input type="checkbox"/>	Primo High Pressure Tire	<input type="checkbox"/> 24"x1" <input type="checkbox"/> 25"x1" or <input type="checkbox"/> 26"x1"	<input type="checkbox"/> Blue <input type="checkbox"/> Red	E2211/E2212	\$	100
<input type="checkbox"/>	Low Pressure Tire	<input type="checkbox"/> 24"x1-3/8" or <input type="checkbox"/> 26"x1-3/8"	Gray Only	E2211/E2212	\$	STD
<input type="checkbox"/>	Schwalbe Marathon Plus High Pressure Tire	<input type="checkbox"/> 24"x1", <input type="checkbox"/> 25"x1" or <input type="checkbox"/> 26"x1"	Black Only	E2211/E2212	\$	170
<input type="checkbox"/>	Solid Tire	<input type="checkbox"/> 24"x1" <input type="checkbox"/> 25"x1" <input type="checkbox"/> 26"x1"	Black	E2218	\$	219
<input type="checkbox"/>	Moderate Knobby Tire (EuroTrek)	24"x1-3/8" (37-540)	Gray Only	E2211/E2212	\$	155
<input type="checkbox"/>	Kobra Knobby Tire	24"x 2" (50-540)	Gray Only <input type="checkbox"/> Blue Line <input type="checkbox"/> Red Line	E2211/E2212	\$	155
<input type="checkbox"/>	Kobra Knobby Tire	26"x 2" (50-559)	Gray Only <input type="checkbox"/> Blue Line <input type="checkbox"/> Red Line	E2211/E2212	\$	155
<input type="checkbox"/>	Nevegal Knobby Tire	24" x 1.95"(50-540)	Black Only	E2211/E2212	\$	155
<input type="checkbox"/>	Kenda Knobby Tire(Kwick Drumlin)	(559) 26" X 1.75 - 2.25	Black Only	E2211/E2212	\$	155
<input type="checkbox"/>	Flat-Free Inserts For 24"x1-3/8"	Only for 24"		E2211/E2213	\$	155

CASTERS						
SIZE	TIRE WIDTH	HUB COLOR	TIRE COLOR	DESCRIPTION		
<input type="checkbox"/> 3"	1"	Black Hub	Black Tire Only	Polyurethane	K0077	\$ STD
<input type="checkbox"/> 3"	1"	Plastic Black Hub	Clear Tire Only	Lighted, Polyurethane	A9900	\$ 86
<input type="checkbox"/> 3"	1"	Red Hub	Red Tire Only	Polyurethane	E2222	\$ STD
<input type="checkbox"/> 3"	1"	Black Hub	Clear Tire Only	Polyurethane	E2222	\$ STD
<input type="checkbox"/> 3"	1"	Aluminum Silver Hub	Black Tire Only	Made By Frog Legs	K0071	\$ 209
<input type="checkbox"/> 3"	1"	Aluminum Black Hub	Black Tire Only	Made By Frog Legs	E2222	\$ 209
<input type="checkbox"/> 3"	1.5"	Aluminum Silver Hub	Black Tire Only	Soft Roll Made By Frog Legs	E2222	\$ 209
<input type="checkbox"/> 3"	1.5"	Aluminum Black Hub	Black Tire Only	Soft Roll Made By Frog Legs	E2222	\$ 209
<input type="checkbox"/> 4"	1 1/8"	Plastic Black Hub	Black Tire Only	Polyurethane Not Available with Narrow Frog Leg Forks	E2222	\$ STD
<input type="checkbox"/> 4"	1"	Plastic Black Hub	Clear Only	Lighted, Polyurethane	E2221	\$ 86
<input type="checkbox"/> 4"	1"	Aluminum Silver Hub	Black Tire Only	Made By Frog Legs	E2214	\$ 209
<input type="checkbox"/> 4"	1"	Aluminum Black Hub	Black Tire Only	Made By Frog Legs	E2214	\$ 190
<input type="checkbox"/> 4"	1.5"	Aluminum Silver Hub	Tire <input type="checkbox"/> Black <input type="checkbox"/> Blue <input type="checkbox"/> Red	Soft Roll Made By Frog Legs	E1015	\$ 209
<input type="checkbox"/> 4"	1.5"	Aluminum Black Hub	Black Tire Only	Soft Roll Made By Frog Legs	E2214	\$ 209
<input type="checkbox"/> 5"	1"	Composite Black Hub	Black Tire Only	Polyurethane	E2222	\$ STD
<input type="checkbox"/> 5"	1"	Plastic Black Hub	Clear Tire Only	Lighted, Polyurethane	A9900	\$ 86
<input type="checkbox"/> 5"	1"	Aluminum Silver Hub	Black Tire Only	Made By Frog Legs	A9900	\$ 209
<input type="checkbox"/> 5"	1"	Aluminum Black Hub	Black Tire Only	Made By Frog Legs	E2214	\$ 209
<input type="checkbox"/> 5"	1.5"	Aluminum Silver Hub	Tire <input type="checkbox"/> Black <input type="checkbox"/> Blue <input type="checkbox"/> Red	Soft Roll Made By Frog Legs	K0072	\$ 209
<input type="checkbox"/> 5"	1.5"	Aluminum Black Hub	Black Tire Only	Soft Roll Made By Frog Legs	E2222	\$ 209
<input type="checkbox"/> 6"	1.5"	Aluminum Black Hub	Black Tire Only	Soft Roll Made By Frog Legs	E2222	\$ 234
<input type="checkbox"/> 6"	1.5"	Aluminum Silver Hub	Black Tire Only	Soft Roll Made By Frog Legs	E2222	\$ 234
<input type="checkbox"/> "	<input type="checkbox"/> 1"OR <input type="checkbox"/> 1.5"	Hub Color:	FL Tread Color:	Soft Roll Made By Frog Legs	E2222	\$ CFP

FORKS					
<input type="checkbox"/>	Frog Leg Shields(4 pcs) Only for Frog Leg Forks				\$ 30
<input type="checkbox"/>	STD Aluminum Forks with Suspension Springs				\$ STD
	Extra Options for Aluminum Forks	<input type="checkbox"/> without Suspension Springs	E1015	\$	NCO
		<input type="checkbox"/> With Quick Release Axles	K0073	\$	141
<input type="checkbox"/>	Frog Leg Suspension Forks 1" Wide (For 3", 4" x 1" width Caster and 5" STD Caster, 5" lighted Caster)	Not available with Quick Release Axle	E1015	\$	607
	*User's Weight _____ Color <input type="checkbox"/> Anodized Black <input type="checkbox"/> Anodized Silver				
<input type="checkbox"/>	Frog Leg Suspension Forks 1.5" Wide (For 3", 4" x 1.5" width Caster and 5" x 1"& 5" x 1.5" Casters)	Not available with Quick Release Axle	E1015	\$	607
	*User's Weight _____ Color <input type="checkbox"/> Anodized Black <input type="checkbox"/> Anodized Silver				

Valid from 2023 Prices & Specifications Are Subject To Change Without Notice.

F WHEELS

WHEELS															
Wire Wheels	<input type="checkbox"/> 24" (540)		\$ NCO												
	<input type="checkbox"/> 25" (559)	\$ NCO												
	<input type="checkbox"/> 26" (590)		\$ NCO												
Y-360 Billet Wheels <small>*Max. Capacity 220Lbs *Camber 0- 2" max *Not for Sports or Rugged use</small>	<input type="checkbox"/> 25" (559) Style <input type="checkbox"/> Saw Blade		\$ 1,495												
Y-360 Billet Wheels MOD Style <small>*Max. Capacity 220Lbs *Camber 0- 2" max *Not for Sports or Rugged use</small>	<input type="checkbox"/> 25" (559) Only Style <input type="checkbox"/> Tribal Sun <input type="checkbox"/> Girls <input type="checkbox"/> Eagle <input type="checkbox"/> Holy Cross <input type="checkbox"/> Hono(Flames) Specify Powder Coat Color for Insert Only () *Choose from Frame Colors		\$ 1,783												
Extra Options for		<input type="checkbox"/> Powder-Coated Spokes Only () *Choose from Frame Colors (\$250 up charge)													
Spinergy Spox 18 Spokes 	<input type="checkbox"/> 24" (540) <input type="checkbox"/> 25" (559) <input type="checkbox"/> 26" (590) Spoke Color <input type="checkbox"/> Black With Silver Hub <input type="checkbox"/> Red With Black Hub <input type="checkbox"/> Yellow With Black Hub <input type="checkbox"/> Blue With Black Hub <input type="checkbox"/> White With Black Hub		\$ 998												
	<input type="checkbox"/> Custom Color Spoke Pattern	<table border="1"> <thead> <tr> <th></th> <th>Left Wheel</th> <th>Right Wheel</th> </tr> </thead> <tbody> <tr> <td>Spokes Inside</td> <td></td> <td></td> </tr> <tr> <td>Color Outside</td> <td></td> <td></td> </tr> <tr> <td>Hub Color</td> <td><input type="checkbox"/> Black/<input type="checkbox"/> Silver</td> <td><input type="checkbox"/> Black/<input type="checkbox"/> Silver</td> </tr> </tbody> </table>		Left Wheel	Right Wheel	Spokes Inside			Color Outside			Hub Color	<input type="checkbox"/> Black/ <input type="checkbox"/> Silver	<input type="checkbox"/> Black/ <input type="checkbox"/> Silver	\$ 1,108
		Left Wheel	Right Wheel												
Spokes Inside															
Color Outside															
Hub Color	<input type="checkbox"/> Black/ <input type="checkbox"/> Silver	<input type="checkbox"/> Black/ <input type="checkbox"/> Silver													
Spinergy LX 12 Spokes 	<input type="checkbox"/> 24" (540) <input type="checkbox"/> 25" (559) <input type="checkbox"/> 26" (590) Spoke Color <input type="checkbox"/> Black With Silver Hub <input type="checkbox"/> Red With Black Hub <input type="checkbox"/> Yellow With Black Hub <input type="checkbox"/> Blue With Black Hub <input type="checkbox"/> White With Black Hub <input type="checkbox"/> Neon Green With Black Hub <input type="checkbox"/> Pink With Black Hub <input type="checkbox"/> Orange With Black Hub <input type="checkbox"/> Purple With Black Hub		\$ 1,252												
	<input type="checkbox"/> Custom Color Spoke Pattern	<table border="1"> <thead> <tr> <th></th> <th>Left Wheel</th> <th>Right Wheel</th> </tr> </thead> <tbody> <tr> <td>Spokes Inside</td> <td></td> <td></td> </tr> <tr> <td>Color Outside</td> <td></td> <td></td> </tr> <tr> <td>Hub Color</td> <td><input type="checkbox"/> Black/<input type="checkbox"/> Silver</td> <td><input type="checkbox"/> Black/<input type="checkbox"/> Silver</td> </tr> </tbody> </table>		Left Wheel	Right Wheel	Spokes Inside			Color Outside			Hub Color	<input type="checkbox"/> Black/ <input type="checkbox"/> Silver	<input type="checkbox"/> Black/ <input type="checkbox"/> Silver	\$ 1,362
		Left Wheel	Right Wheel												
Spokes Inside															
Color Outside															
Hub Color	<input type="checkbox"/> Black/ <input type="checkbox"/> Silver	<input type="checkbox"/> Black/ <input type="checkbox"/> Silver													
Spinergy X-Laced Sport Lite Extreme "XSLX" 24 Spokes 	<input type="checkbox"/> 24" (540) <input type="checkbox"/> 25" (559) <input type="checkbox"/> 26" (590) Spoke Color <input type="checkbox"/> Black With Silver Hub <input type="checkbox"/> Red With Black Hub <input type="checkbox"/> Yellow With Black Hub <input type="checkbox"/> Blue With Black Hub <input type="checkbox"/> White With Black Hub <input type="checkbox"/> Neon Green With Black Hub <input type="checkbox"/> Pink With Black Hub <input type="checkbox"/> Orange With Black Hub <input type="checkbox"/> Purple With Black Hub		\$ 1,210												
	<input type="checkbox"/> Custom Color Spoke Pattern	<table border="1"> <thead> <tr> <th></th> <th>Left Wheel</th> <th>Right Wheel</th> </tr> </thead> <tbody> <tr> <td>Spokes Inside</td> <td></td> <td></td> </tr> <tr> <td>Color Outside</td> <td></td> <td></td> </tr> <tr> <td>Hub Color</td> <td><input type="checkbox"/> Black/<input type="checkbox"/> Silver</td> <td><input type="checkbox"/> Black/<input type="checkbox"/> Silver</td> </tr> </tbody> </table>		Left Wheel	Right Wheel	Spokes Inside			Color Outside			Hub Color	<input type="checkbox"/> Black/ <input type="checkbox"/> Silver	<input type="checkbox"/> Black/ <input type="checkbox"/> Silver	\$ 1,320
		Left Wheel	Right Wheel												
Spokes Inside															
Color Outside															
Hub Color	<input type="checkbox"/> Black/ <input type="checkbox"/> Silver	<input type="checkbox"/> Black/ <input type="checkbox"/> Silver													

Valid from 2023 Prices & Specifications Are Subject To Change Without Notice.

Spinergy Sport Lite Extreme "SLX" 24 Spoke



24" (540) 25" (559) 26" (590)
 Spoke Color Black Red Yellow Blue
 With Silver Hub With Black Hub With Black Hub With Black Hub
 White Neon Green Pink Orange Purple
 With Black Hub With Black Hub With Black Hub With Black Hub With Black Hub

Custom Color Spoke Pattern

		Left Wheel	Right Wheel
Spokes	Inside		
	Outside		
Hub Color		<input type="checkbox"/> Black/ <input type="checkbox"/> Silver	<input type="checkbox"/> Black/ <input type="checkbox"/> Silver

\$ 1,166

\$ 1,276

Spinergy Lite Extreme "XLX" X-Laced-12 Spoke



24" (540) 25" (559) 26" (590)
 Spoke Color Black Red Yellow Blue
 With Silver Hub With Black Hub With Black Hub With Black Hub
 White Neon Green Pink Orange Purple
 With Black Hub With Black Hub With Black Hub With Black Hub With Black Hub

Custom Color Spoke Pattern

		Left Wheel	Right Wheel
Spokes	Inside		
	Outside		
Hub Color		<input type="checkbox"/> Black/ <input type="checkbox"/> Silver	<input type="checkbox"/> Black/ <input type="checkbox"/> Silver

\$ 1,210

\$ 1,320

Spinergy Blade "LXL" 18 Spoke



24" (540) 25" (559) 26" (590)
 Spoke Color Black Red Yellow Blue
 With Silver Hub With Black Hub With Black Hub With Black Hub
 White Neon Green Pink Orange Purple
 With Black Hub With Black Hub With Black Hub With Black Hub With Black Hub

Custom Color Spoke Pattern

		Left Wheel	Right Wheel
Spokes	Inside		
	Outside		
Hub Color		<input type="checkbox"/> Black	<input type="checkbox"/> Black

\$ 1,040

\$ 1,150

HANDRIM

Type	<input type="checkbox"/> Standard For 24", 25" or 26" Wheel Anodized Black	\$ STD
	<input type="checkbox"/> Vinyl Coated For 24", 25" & 26" Wheels Not available with Y-360 Billet Wheels	\$ 200
	<input type="checkbox"/> Spinergy Silver Brushed Anodized For 24", 25" & 26"	\$ 176
	<input type="checkbox"/> Natural Fit For 24", 25" & 26" Wheel	
	<input type="checkbox"/> Standard Grip (Not available with short tabs.) Not available with Y-360 Billet Wheels	\$ 570
	<input type="checkbox"/> Super Grip (Not available with short tabs.) Not available with Y-360 Billet Wheels	\$ 645
	<input type="checkbox"/> Without Thumb Grip (Not available with Y-360 Billet Wheels)	\$ 338
	<input type="checkbox"/> Natural Fit(LT) For 24", 25" & 26" Wheel	
	<input type="checkbox"/> Standard Grip (Not available with short tabs.) Not available with Y-360 Billet Wheels	\$ 629
	<input type="checkbox"/> Super Grip (Not available with short tabs.) Not available with Y-360 Billet Wheels	\$ 706
	<input type="checkbox"/> Without Thumb Grip (Not available with Y-360 Billet Wheels)	\$ 400
	<input type="checkbox"/> The Surge Handrims * Not available with Y-360 Billet Wheels	\$ 553
	<input type="checkbox"/> The Surge Handrims (LT) * Not available with Y-360 Billet Wheels	\$ 603
	<input type="checkbox"/> Spinergy Flex Rim Available only on Spinergy LX & XLX	\$ CFP
	<input type="checkbox"/> The Q-Grip Handrims : anti-slip, latex-free, neoprene coating * Not available with Y-360 Billet Wheels	\$ 543
	<input type="checkbox"/> OMIT HANDRIMS	\$ NCO

TAB LENGTH	<input type="checkbox"/> Long Tab (STD inside clearance 3/4") Not available with Y-360 Billet Wheels *	STD
	<input type="checkbox"/> Short Tab (Inside clearance 1/2") * Not available with Natural Fit Handrim with thumb grip	\$ STD
	<input type="checkbox"/> Short Tab (Set closest to wheel cut off excess) * Not available with Y-360 wheel	\$ 35

G CHAIR OPTIONS 1 / 3

SEAT CUSHION									
SUPRACOR® WHEELCHAIR CUSHIONS									
Stimulite® Contoured Cushion *Black Upholstery only *Comes with Zipper Pouch <input type="checkbox"/> Extra Sensitive (\$35 up charge) <input type="checkbox"/> Sling Style Bottom (\$52 up charge) <input type="checkbox"/> Custom Size (\$- CFP) W(") x D(") <input type="checkbox"/> Extra Cover (\$120 up charge)	<input type="checkbox"/> W14"xD16" (CD1416)					E2603	\$ 707	
	<input type="checkbox"/> W16"xD16" (CD1616)					E2603	\$ 707	
	<input type="checkbox"/> W16"xD18" (CD1618)					E2603	\$ 707	
	<input type="checkbox"/> W18"xD16" (CD1816)					E2603	\$ 707	
	<input type="checkbox"/> W18"xD18" (CD1818)					E2603	\$ 707	
	<input type="checkbox"/> W18"xD20" (CD1820)					E2603	\$ 714	
	<input type="checkbox"/> W20"xD16" (CD2016)					E2603	\$ 714	
	<input type="checkbox"/> W20"xD18" (CD2018)					E2603	\$ 714	
	<input type="checkbox"/> W20"xD20" (CD2020)					E2603	\$ 734	
	Stimulite® Slimline Cushion *Black Upholstery only <input type="checkbox"/> Extra Sensitive (\$35 up charge) <input type="checkbox"/> Sling Style Bottom (\$52 up charge) <input type="checkbox"/> Custom Size (\$- CFP) W(") x D(") <input type="checkbox"/> Extra Cover (\$86 up charge)	<input type="checkbox"/> W14"xD16" (SM1416)					E2603	\$ 446
<input type="checkbox"/> W16"xD16" (SM1616)						E2603	\$ 446	
<input type="checkbox"/> W16"xD18" (SM1618)						E2603	\$ 446	
<input type="checkbox"/> W18"xD18" (SM1818)						E2603	\$ 446	
<input type="checkbox"/> W18"xD20" (SM1820)						E2603	\$ 490	
<input type="checkbox"/> W20"xD16" (SM2016)						E2603	\$ 490	
<input type="checkbox"/> W20"xD18" (SM2018)						E2603	\$ 490	
<input type="checkbox"/> W20"xD20" (SM2020)						E2603	\$ 518	
Stimulite® Corbee Pediatric *Black Upholstery only <input type="checkbox"/> Extra Cover (\$86 up charge)	<input type="checkbox"/> W10"xD10" (PD1010)					E2603	\$ 342	
	<input type="checkbox"/> W12"xD12" (PD1212)					E2603	\$ 342	
	<input type="checkbox"/> W14"xD14" (PD1414)					E2603	\$ 342	
								<input type="checkbox"/> Extra Sensitive (\$35 up charge) <input type="checkbox"/> Sling Style Bottom (\$52 up charge) <input type="checkbox"/> Custom Size W(") x D(") (\$- CFP)	
ROHO WHEELCHAIR CUSHIONS									
Choose Size	<input type="checkbox"/> 4" HIGH PROFILE® QUADTRO SELECT® CUSHION *Black Upholstery			<input type="checkbox"/> Extra Cover (\$+100)		*Black Upholstery only E2622-2623		\$ 669
	<input type="checkbox"/> W12"xD12"	<input type="checkbox"/> W12"xD13"	<input type="checkbox"/> W13"xD13"	<input type="checkbox"/> W13"xD15"	<input type="checkbox"/> W13"xD16"	<input type="checkbox"/> W15"xD13"	<input type="checkbox"/> W15"xD15"		
	<input type="checkbox"/> W15"xD16"	<input type="checkbox"/> W15"xD18"	<input type="checkbox"/> W16"xD15"	<input type="checkbox"/> W16"xD16"	<input type="checkbox"/> W16"xD18"	<input type="checkbox"/> W16"xD20"	<input type="checkbox"/> W18"xD15"		
	<input type="checkbox"/> W18"xD16"	<input type="checkbox"/> W18"xD18"	<input type="checkbox"/> W18"xD20"	<input type="checkbox"/> W18"xD22"	<input type="checkbox"/> W20"xD16"	<input type="checkbox"/> W20"xD18"	<input type="checkbox"/> W20"xD20"		
	<input type="checkbox"/> W20"xD22"	<input type="checkbox"/> W22"xD18"	<input type="checkbox"/> W22"xD20"	<input type="checkbox"/> W22"xD22"	<input type="checkbox"/> Custom Size W(") x D(") (\$+CFP)				
Choose Size	<input type="checkbox"/> 3" MID PROFILE® QUADTRO SELECT® CUSHION *Black Upholstery only			<input type="checkbox"/> Extra Cover (\$+100)		E2622-2623		\$ 669
	<input type="checkbox"/> W15"xD15"	<input type="checkbox"/> W15"xD16"	<input type="checkbox"/> W16"xD16"	<input type="checkbox"/> W16"xD18"	<input type="checkbox"/> W18"xD16"	<input type="checkbox"/> W18"xD18"			
	<input type="checkbox"/> Custom Size W(") x D(") (\$+CFP)								
Choose Size	<input type="checkbox"/> 2" LOW PROFILE® QUADTRO SELECT® CUSHION *Black Upholstery only			<input type="checkbox"/> Extra Cover (\$+100)		E2622-2623		\$ 669
	<input type="checkbox"/> W12"xD12"	<input type="checkbox"/> W12"xD13"	<input type="checkbox"/> W13"xD13"	<input type="checkbox"/> W13"xD15"	<input type="checkbox"/> W13"xD16"	<input type="checkbox"/> W15"xD13"	<input type="checkbox"/> W15"xD15"		
	<input type="checkbox"/> W15"xD16"	<input type="checkbox"/> W15"xD18"	<input type="checkbox"/> W16"xD15"	<input type="checkbox"/> W16"xD16"	<input type="checkbox"/> W16"xD18"	<input type="checkbox"/> W16"xD20"	<input type="checkbox"/> W18"xD15"		
	<input type="checkbox"/> W18"xD16"	<input type="checkbox"/> W18"xD18"	<input type="checkbox"/> W18"xD20"	<input type="checkbox"/> W20"xD16"	<input type="checkbox"/> W20"xD18"	<input type="checkbox"/> W20"xD20"			
	<input type="checkbox"/> Custom Size W(") x D(") (\$+CFP)								
THE CURVE CUSHION *Black Upholstery only <input type="checkbox"/> Extra Cover (\$+ 46	<input type="checkbox"/> W10"xD10"	<input type="checkbox"/> W10"xD11"	<input type="checkbox"/> W10"xD11"	<input type="checkbox"/> W10"xD12"	<input type="checkbox"/> W11"xD12"	<input type="checkbox"/> W12"xD12"		\$ 146	
	<input type="checkbox"/> W12"xD13"	<input type="checkbox"/> W12"xD14"	<input type="checkbox"/> W13"xD11"	<input type="checkbox"/> W13"xD12"	<input type="checkbox"/> W13"xD13"	<input type="checkbox"/> W13"xD14"			
	<input type="checkbox"/> W14"xD14"	<input type="checkbox"/> W14"xD15"	<input type="checkbox"/> W14"xD16"	<input type="checkbox"/> W15"xD14"	<input type="checkbox"/> W15"xD15"	<input type="checkbox"/> W15"xD16"			
	<input type="checkbox"/> W16"xD14"	<input type="checkbox"/> W16"xD15"	<input type="checkbox"/> W16"xD16"	<input type="checkbox"/> W16"xD17"	<input type="checkbox"/> W16"xD18"	<input type="checkbox"/> W17"xD16"			
	<input type="checkbox"/> W17"xD17"	<input type="checkbox"/> W17"xD18"	<input type="checkbox"/> W18"xD16"	<input type="checkbox"/> W18"xD17"	<input type="checkbox"/> W18"xD18"				

G CHAIR OPTIONS 2 / 3

SEAT CUSHION			
Exgel Kaji Cushion			
For Comfortable Sitting To Prevent Pressure Sores			
<input type="checkbox"/> Owl Regular(1.6" Thick) Incontinence Cover Only	<input type="checkbox"/> W14"xD16" <input type="checkbox"/> W15"xD16" <input type="checkbox"/> W16"xD16" <input type="checkbox"/> W18"xD16" <input type="checkbox"/> Extra Cover \$104 * No Custom Sizes	E2603 \$ 362 E2603 \$ 362 E2603 \$ 362 E2603 \$ 408
<input type="checkbox"/> Owl High(3.1" Thick) Incontinence Cover Only	<input type="checkbox"/> W14"xD16" <input type="checkbox"/> W15"xD16" <input type="checkbox"/> W16"xD16" <input type="checkbox"/> W18"xD16" <input type="checkbox"/> W18"xD18" <input type="checkbox"/> Extra Cover \$104 * No Custom Sizes	E2603 \$ 437 E2603 \$ 437 E2603 \$ 437 E2603 \$ 495 E2603 \$ 495
<input type="checkbox"/> Owl Contour(3.0" Thick) Incontinence Cover Only	<input type="checkbox"/> W14"xD16" <input type="checkbox"/> W15"xD16" <input type="checkbox"/> W16"xD16" <input type="checkbox"/> W18"xD16" <input type="checkbox"/> Extra Cover \$104 * No Custom Sizes	E2603 \$ 454 E2603 \$ 454 E2603 \$ 454 E2603 \$ 495
<input type="checkbox"/> Owl Deep Contour(4.3" Thick) <input type="checkbox"/> W14"xD16" \$518 <input type="checkbox"/> W15"xD16" \$518 <input type="checkbox"/> W16"xD16" \$518 <input type="checkbox"/> W18"xD16" \$558		* No Custom Sizes- Incontinence Cover Only <input type="checkbox"/> Extra Cover \$104	
<input type="checkbox"/> Standard Regular(1.4" Thick) Easy to Use Flat Style (superior pressure redistribution)	 <input type="checkbox"/> Extra Cover \$104	E2622-2623 * No Custom Sizes- Incontinence Cover Only
<input type="checkbox"/> Standard High(2.6" Thick) Incontinence Cover Only *Black Upholstery only	 <input type="checkbox"/> Extra Cover \$104	E2622
<input type="checkbox"/> Standard Anti-Thrust(2.6" Thick) * No Custom Sizes Incontinence Cover Only	<input type="checkbox"/> W16 x D16 \$460 <input type="checkbox"/> W18 x D16 \$500 <input type="checkbox"/> W18 x D18 \$500	Prevents Unwanted Forward Movement of lower back and hip bone <input type="checkbox"/> Extra Cover \$104	
<input type="checkbox"/> Lite Regular(2.2" Thick)	<input type="checkbox"/> W16" x D16" \$374 <input type="checkbox"/> W18" x D16" \$397 <input type="checkbox"/> W18" x D18" \$397	* No Custom Sizes- Incontinence Cover Only <input type="checkbox"/> Extra Cover \$104	
<input type="checkbox"/> Lite High(3.0" Thick)	<input type="checkbox"/> W16" x D16" \$408 <input type="checkbox"/> W18" x D16" \$431 <input type="checkbox"/> W18" x D18" \$431	* No Custom Sizes- Incontinence Cover Only <input type="checkbox"/> Extra Cover \$104	

H CHAIR OPTIONS 3 / 3

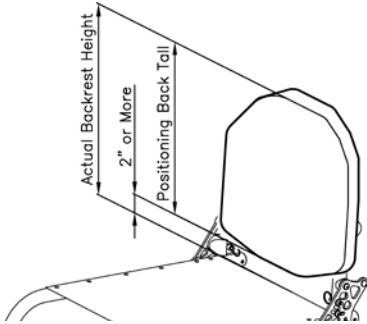
POSITIONING BACK					
<p>*Note : Actual height of the backrest will increase 2" or more.</p> 					
ADI CARBON BACKREST (Support Contour-ACTIVE 2.5")					
Mounting Hardware: <input type="checkbox"/> 2 Point Pro <input type="checkbox"/> Quick Release					
Height	<input type="checkbox"/> LOW (10" Tall) *Backrest Height requires 12" or more *Available 13"-19" width	Width (")	E2613	\$	986
	<input type="checkbox"/> Medium (13" Tall) *Backrest Height requires 15" or more *Available 13"-19" width	Width (")	E2613	\$	1,078
<input type="checkbox"/> Add Privacy Flap	<input type="checkbox"/> Standard (16" Tall) *Backrest Height requires 18" or more *Available 13"-19" width	Width (")	E2613	\$	1,164
(\$80 up charge)	<input type="checkbox"/> Custom Size (" Tall) x (" width)		E2613	\$	CFP
ADI ALUMINUM BACKREST (Support Contour-ACTIVE 2.5")					
Mounting Hardware: <input type="checkbox"/> 2 Point Pro <input type="checkbox"/> Quick Release					
Height	<input type="checkbox"/> LOW (10" Tall) *Backrest Height requires 12" or more *Available 10"-20" width	Width (")	E2613	\$	807
	<input type="checkbox"/> Medium (13" Tall) *Backrest Height requires 15" or more *Available 12"-20" width	Width (")	E2613	\$	827
<input type="checkbox"/> Add Privacy Flap	<input type="checkbox"/> Standard (16" Tall) *Backrest Height requires 18" or more *Available 14"-20" width	Width (")	E2613	\$	846
(\$80 up charge)	<input type="checkbox"/> Tall (18" Tall) *Backrest Height requires 20" or more *Available 16"-20" width	Width (")	E2613	\$	866
	<input type="checkbox"/> X-Tall (20" Tall) *Backrest Height requires 22" or more *Available 16"-20" width	Width (")	E2613	\$	886
	<input type="checkbox"/> Custom Size (" Tall) x (" width)		E2613	\$	CFP
ADI ALUMINUM BACKREST (Support Contour-DEEP 4") *Not Available with Lateral Supports					
Mounting Hardware: <input type="checkbox"/> 2 Point Pro <input type="checkbox"/> Quick Release					
Height	<input type="checkbox"/> LOW (10" Tall) *Backrest Height requires 12" or more *Available 10"-20" width	Width (")	E2615	\$	940
	<input type="checkbox"/> Medium (13" Tall) *Backrest Height requires 15" or more *Available 12"-20" width	Width (")	E2615	\$	959
<input type="checkbox"/> Add Privacy Flap	<input type="checkbox"/> Standard (16" Tall) *Backrest Height requires 18" or more *Available 14"-20" width	Width (")	E2615	\$	979
(\$80 up charge)	<input type="checkbox"/> Tall (18" Tall) *Backrest Height requires 20" or more *Available 16"-20" width	Width (")	E2615	\$	998
	<input type="checkbox"/> X-Tall (20" Tall) *Backrest Height requires 22" or more *Available 16"-20" width	Width (")	E2615	\$	1,019
	<input type="checkbox"/> Custom Size (" Tall) x (" width)		E2615	\$	CFP
ADI LATERAL SUPPORTS (Lateral Supports are compatible with only active 2.5" ADI positioning back.)					
<input type="checkbox"/> Stationary Pad	Pad Size <input type="checkbox"/> Small (3" H x 3" D) <input type="checkbox"/> Medium(3" H x 4" D) <input type="checkbox"/> Large(4.5" H x 4.5" D) <input type="checkbox"/> Large(4" H x 6" D)				
	<input type="checkbox"/> Pair				\$ 422
	<input type="checkbox"/> Left side only or <input type="checkbox"/> Right side only				\$ 211
<input type="checkbox"/> Swing-Out	Pad Size <input type="checkbox"/> Small (3" H x 3" D) <input type="checkbox"/> Medium(3" H x 4" D) <input type="checkbox"/> Large(4.5" H x 4.5" D) <input type="checkbox"/> Large(4" H x 6" D)				
	<input type="checkbox"/> Pair				\$ 688
	<input type="checkbox"/> Left side only or <input type="checkbox"/> Right side only				\$ 344
OTHER					
<input type="checkbox"/> ADI Transfer Board	<input type="checkbox"/> 21" (ADV21) <input type="checkbox"/> 24" (ADV24) <input type="checkbox"/> 29"(ADV29)				\$ 82
<input type="checkbox"/> ADI Push and Transfer Gloves with Leather (one size)(ADGL)					\$ 110
<input type="checkbox"/> ADI Push and Transfer Gloves with Rubber Grip (one size) (ADG)					\$ 110
<input type="checkbox"/> ADI Carbon Solid Seat (Wide: 18" Max, Depth: 20") ✘ ONLY AVAILABLE WITH COLOURS NON-REMOVABLE SIDE GUARDS					\$ 827
VARILITE® Seating Systems Available					CFP
Please visit for all options www.varilite.com					
NOTE					